

PATTERN HOUSES CRAFT BOX & PINCUSHION

© by Angelina Taranina | @loopy_pattern_design



STORY



Do you have a dream?

Probably every person wants to make his dream come true. Some dream of a house with a view of the ocean, some dream of a carefree life, great travels, the greatest adventures. Nature's curiosity always drives us to venture into the unknown. Traveling is a good way to get to know ourselves, to feel our attachment to home.

It's all about the cartoon "Up," the one of my family's favorites.

Let's crochet these adorable houses. They are not only beautiful, but also very useful. The pin cushion will help not to lose the pins, and the box house is great for storing threads, eyelets and other small accessories.



DESIGNER

Good day, dear friend!

My name is Angelina. I design the patterns for cute crochet toys, for creative people who love to make soulful gifts to loved ones with their own hands. I want people to enjoy crocheting, shut off their brains and to be transported back to childhood thanks to my designs.

These toys you'll want to love, give and have at home. Stock up on yarn, hook and a good mood. I wish you a pleasant time and crochet charming animals.

With love,

Angelina Taranina



CONTACTS



[E-MAIL](#)



[INSTAGRAM](#)



[SHOP](#)

Find more cute patterns in my shop

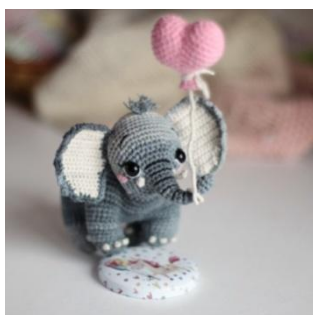

YOU WILL NEED

Yarn	Color	Brand	Weight
A	 70	"Yarnart Jeans" 160 m/50 gr	Sport (12 wpi)
	 3453	"Gazzal Baby Cotton" 165 m/50 gr	Sport (12 wpi)
B	 87	"Yarnart Jeans" 160 m/50 gr	Sport (12 wpi)
	 62	"Alize Cotton Gold Tweed" 330 m/100 gr	Sport (12 wpi)

Materials and tools

THE SAME

- Hook 1,75 mm (for crocheting houses), hook 1,5 mm (for crocheting chimney and crossbar);
- Brown, white, beige, light blue and green threads mouline;
- Colorful threads mouline (I used «Anchor», color 1350);
- Cardboard, thickness 1,25 mm;
- Steel floral wire, diameter 1,6 mm;
- Electrical tape;
- Super Glue "Moment";
- Pins or markers;
- Yarn needle (thick needle with blunt end);
- Scissors;
- Needle;
- Ruler.

PINCUSHION HOUSE

- Needles for cutting (pin needle) - with a bead on the end, 34 mm in length, 225 pcs;
- Round-nose pliers;
- Styrofoam.

CRAFT BOX HOUSE

- Neodymium magnets, diameter 5 mm, 2 pcs.

ON A NOTE

In this pattern you will find 2 design options: a craft box house and a pincushion house. My finished craft box house was 7.5 cm (3 inches) high, the house pincushion - 16 cm (6.3 inches).

You can choose a completely different yarn than suggested here. In this case, you need to choose the size of the hook yourself.

Try to crochet so that the stuffing material is not visible in the toy. If you can't crochet more tightly, take a smaller hook.



CONVENTIONS

l – loop=chain;
sc – single crochet;
sl st – slip stitch;
inc – increase;

dec – decrease;
(...l) – total number of loops in a round;
[...]xN – repeat what is indicated in round brackets N times.

ROOF (Yarn A)

1: 23 loops, turning, 22sc (starting from the 2nd loop from the hook) (22l)

2-28: loops, turning, 22sc only through back loops (22l)

Cut and fix the thread, leaving a long end for sewing (see photo 1).

WALLS AND FLOOR (Yarn B)

1: 13 loops, turning, 12sc (12l)

2: 1 loop, turning, 11sc, inc (13l)

3: 3 loops, turning, 15sc (15l) (see photo 2, 3)

4: 1 loop, turning, 14sc, inc (16l)

5: 1 loop, turning, inc, 15sc (17l)

6: 1 loop, turning, 16sc, inc (18l)

7: 1 loop, turning, inc, 17sc (19l)

8: 1 loop, turning, 18sc, inc (20l)

9: 3 loops, turning, 22sc (22l)

10: 1 loop, turning, 20sc, dec (21l)

11: 1 loop, turning, dec, 19sc (20l)

12: 1 loop, turning, 18sc, dec (19l)

13: 1 loop, turning, dec, 17sc (18l)

14: 1 loop, turning, 16sc, dec (17l)

15: 1 loop, turning, dec, 15sc (16l)

16: 1 loop, turning, 14sc, dec (15l)

17: 1 loop, turning, [dec]x2, 11sc (13l)

18: 1 loop, turning, 11sc, dec (12l)

19: 1 loop, turning, 12sc (12l)

20: 19 loops, turning, 30sc (30l) (see photo 4-7)

21-36: 1 loop, turning, 30sc (30l)

37: 1 loop, turning, 12sc (12l) (see photo 8)

38: 1 loop, turning, 11sc, inc (13l)

39: 3 loops, turning, 15sc (15l)

40: 1 loop, turning, 14sc, inc (16l)

41: 1 loop, turning, inc, 15sc (17l)

42: 1 loop, turning, 16sc, inc (18l)

43: 1 loop, turning, inc, 17sc (19l)

44: 1 loop, turning, 18sc, inc (20l)

45: 3 loops, turning, 22sc (22l)

46: 1 loop, turning, 20sc, dec (21l)

47: 1 loop, turning, dec, 19sc (20l)

48: 1 loop, turning, 18sc, dec (19l)

49: 1 loop, turning, dec, 17sc (18l)

50: 1 loop, turning, 16sc, dec (17l)

51: 1 loop, turning, dec, 15sc (16l)

52: 1 loop, turning, 14sc, dec (15l)

53: 1 loop, turning, [dec]x2, 11sc (13l)

54: 1 loop, turning, 11sc, dec (12l)

55-72: 1 loop, turning, 12sc (12l)

Cut and fix the thread, leaving a very long end for sewing (see photo 9).



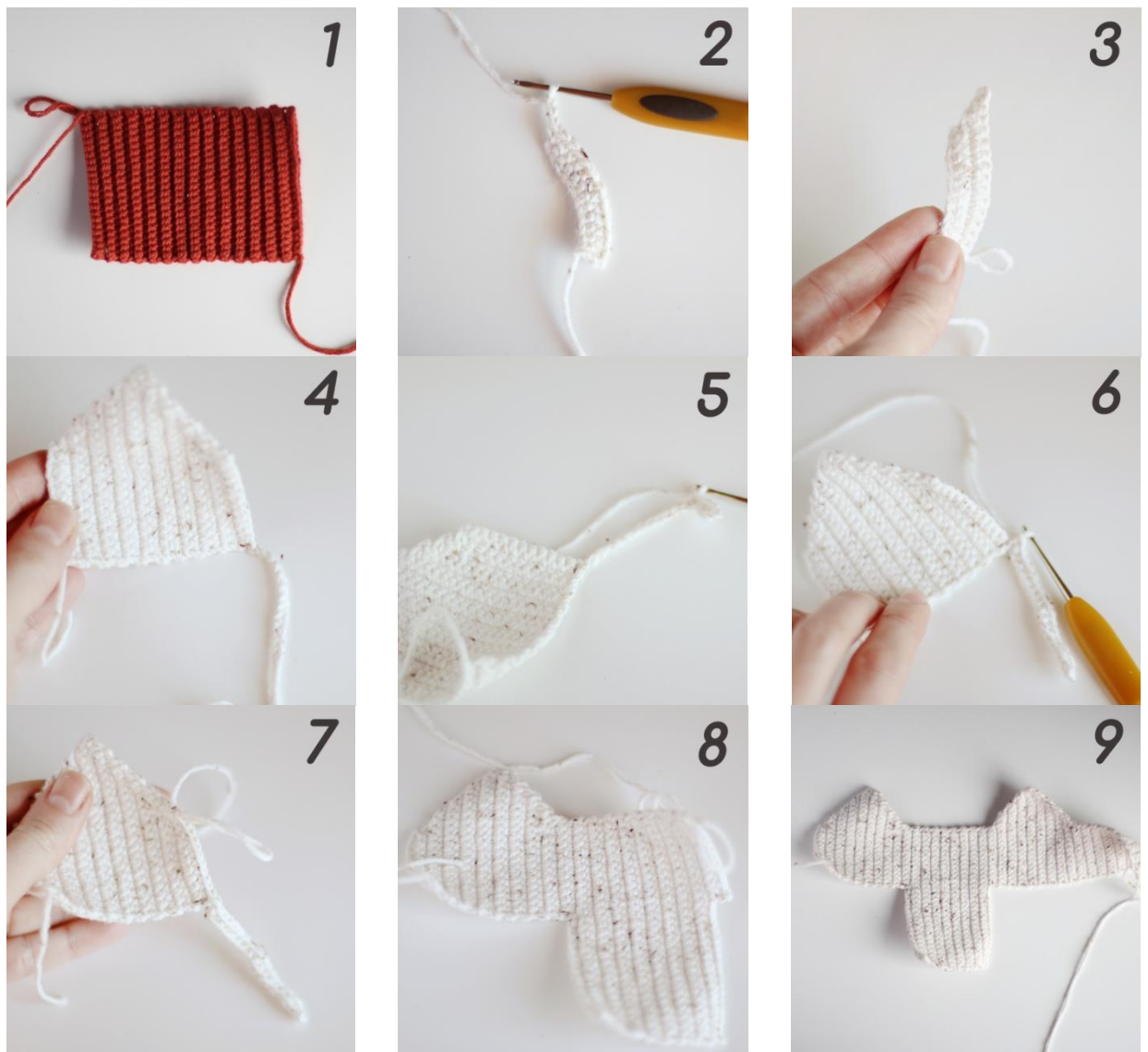

Make the embroidery with mouline threads. Embroider the door with a satin stitch with brown color (see photos 10-15). Embroider the windows with a satin stitch with white or beige color (see photos 16, 17). Embroider frames on the windows with brown, a vase with light blue, twigs with green color. Embroider flowers with a French knots with multicolored mouline threads. Embroider the doorknob with a French knot (see photos 18-21).

Watch «French knot» video tutorial:

<https://youtu.be/eWALE4TD60o>



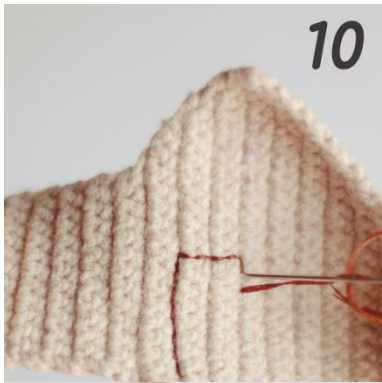

CARDBOARD FRAME

Below is a full-size drawing of the house inner frame, which must be cut out of cardboard.

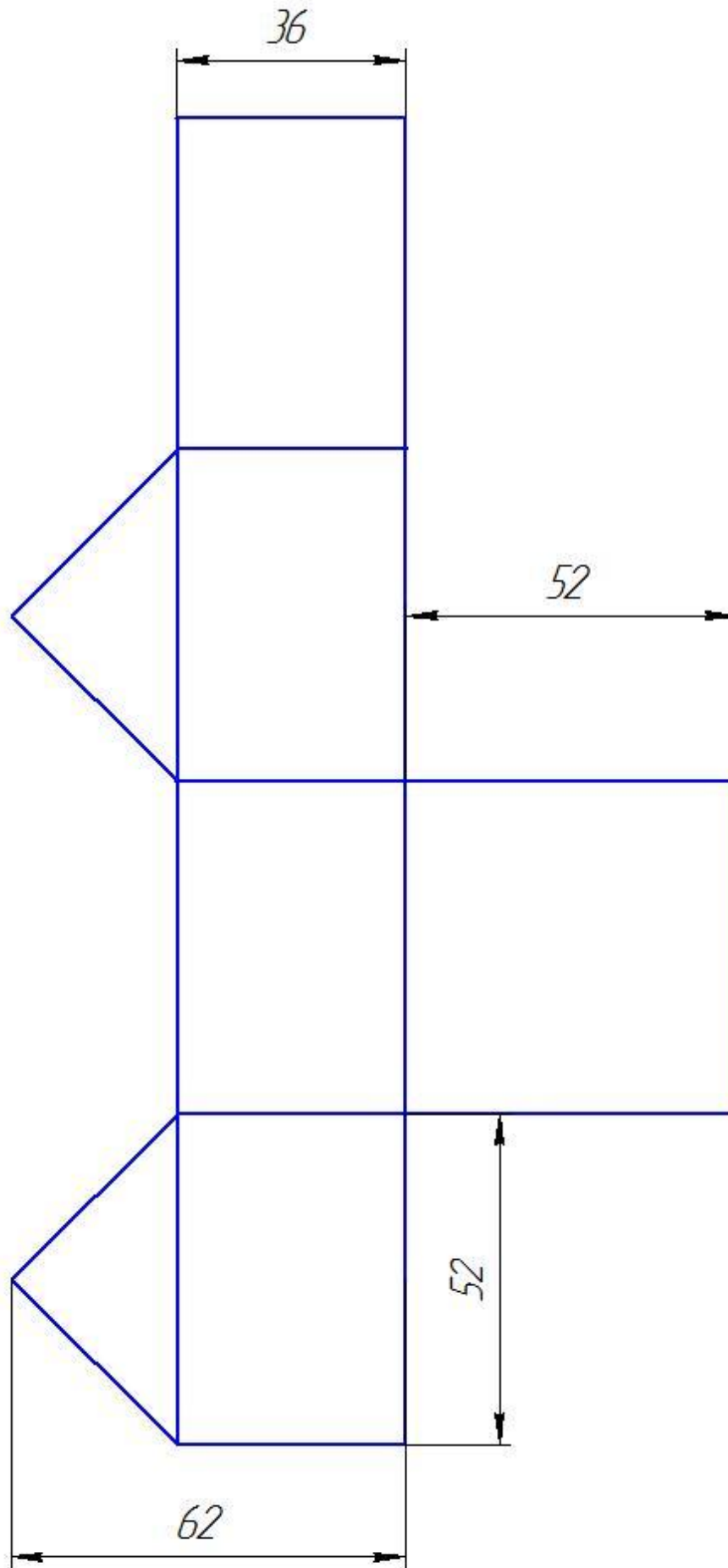

Attention! Before using a drawn, you need to make sure that its size is suitable.

It is necessary to measure the width of the wall on a crocheted fabric (for me it is approximately 54 mm, see photo 22). The cardboard frame should be a couple of mm less than the crocheted fabric $54 - 2 = 52$ mm.

If you get a different value, then you should enlarge or reduce the pattern on the screen so that the size matches the measurement.

Print the drawn on the paper. Or add brightness on the screen to maximum, attach a white paper on it and circle the drawn. Then cut it and transfer to the cardboard.

Press the fold lines with the back of the needle using a ruler (see photos 23, 24). Glue the frame with "Moment" superglue (see photos 25-27).

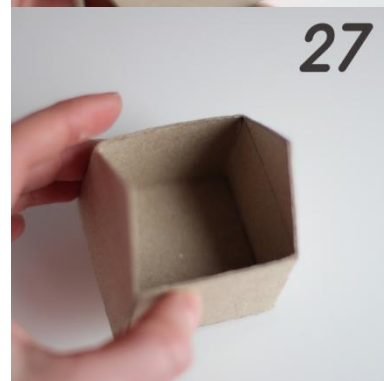
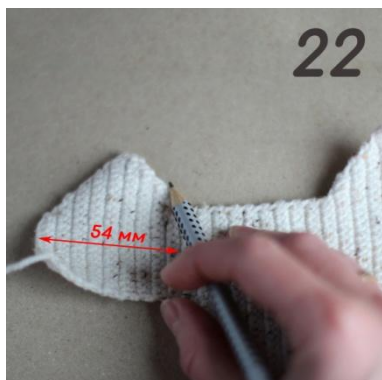

Sew the walls and the floor together as shown on photos 28-36.

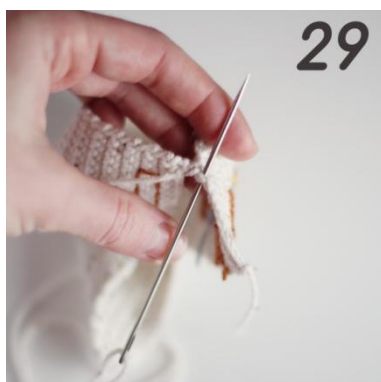

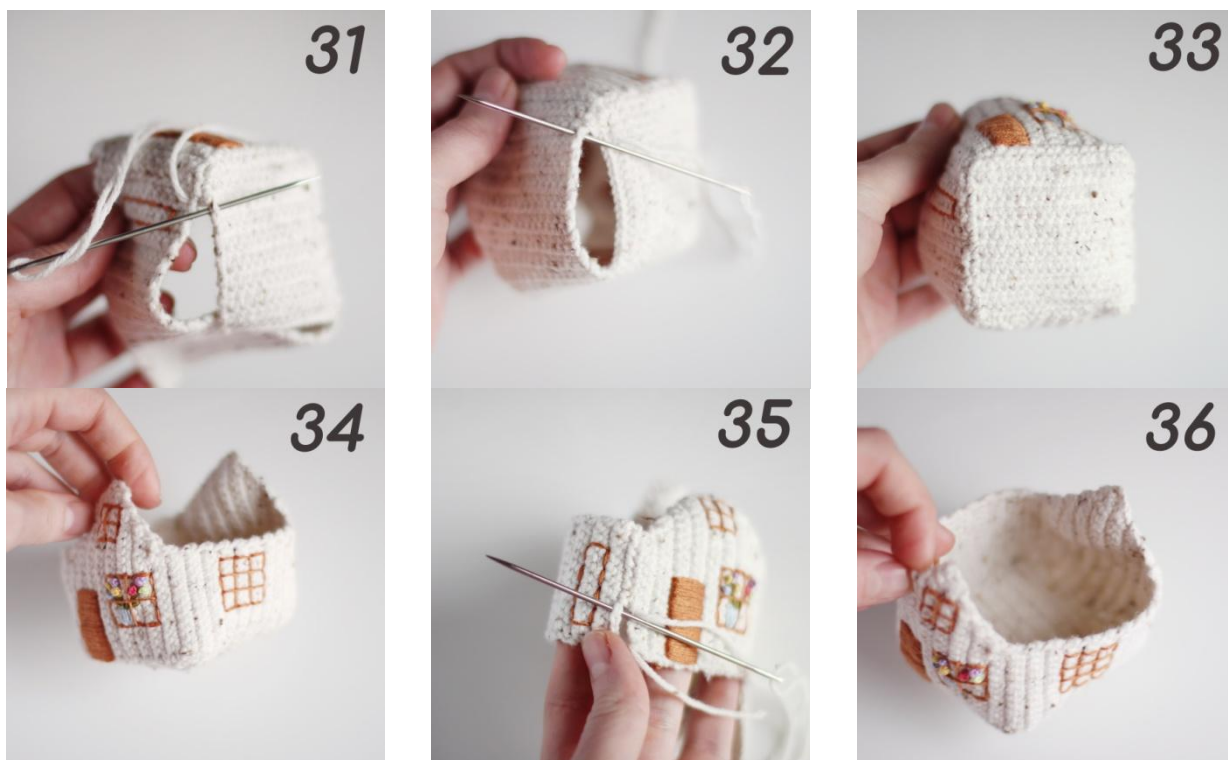

Cut a cube from the styrofoam to the size of the frame for the pincushion house. Place it inside (see photos 37-38). You do not need to cut the styrofoam cube for the craft box house!

Try on the crocheted fabric on the frame to make sure that the frame does not go beyond. If necessary, correct the size again (see photo 39).



Attach a new thread to the open edge of the house and crochet around 76sc, sl st in 1st sc (see photos 40-45).

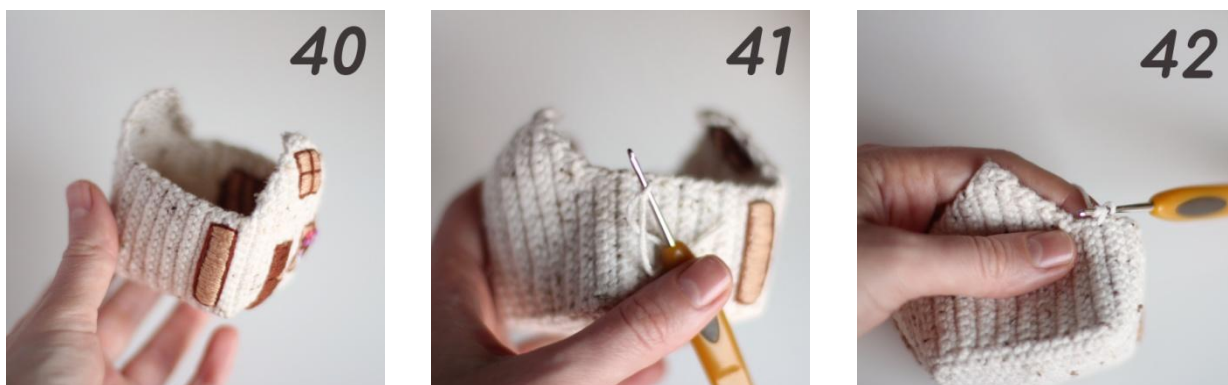

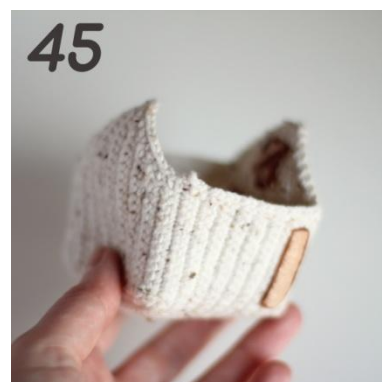
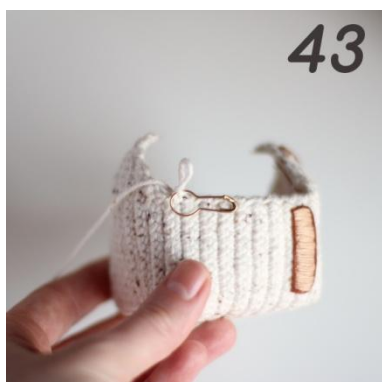

CROSSBAR (Yarn B)

Crochet crossbar with a hook 1,5 mm. You need to divide the thread in half!

At the beginning leave the long end of the thread, it will be needed for sewing.

1: 2 loops, 4sc in 2nd loop from hook (amigurumi ring) (4l)

2-16: 4sc (4l)

Cut and fix the thread, leaving a long end for sewing. Cut off a piece of wire approximately 10 cm (4 inches) long (see photo 46). Pull wire through the crossbar (see photo 47). Use a needle to make 2 holes in the frame (see photo 48). Pull the sewing threads and wire through the holes (see photo 49-51). Bend the ends of wire and wrap electrical tape around it to prevent end from protruding out (see photos 52, 53). Sew the crossbar to the walls, trim and fasten the thread (see photos 54-57).

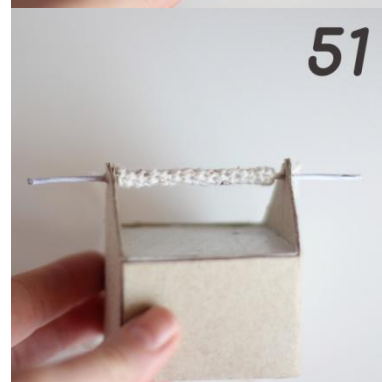
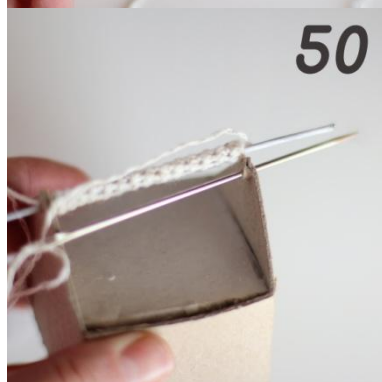
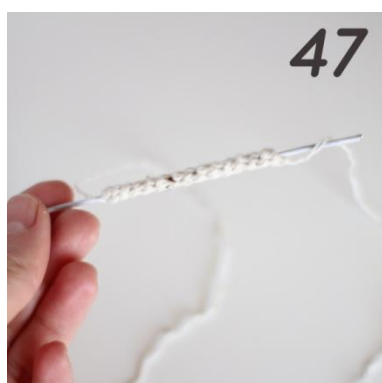



52



53



54



55



56



57

CHIMNEY (Yarn A)

Crochet chimney with a hook 1,5 mm. You need to divide the thread in half!

1: 2 loops, 4sc in 2nd loop from hook (amigurumi ring) (4l)

2: 3sc in each loop (12l)

3: 12sc only through back loops (12l)

4-8: 12sc (12l)

9-11: 1 loop, turning, 8sc (8l)

Cut and fix the thread, leaving a long end for sewing.

Cut a small rectangle out of cardboard along the height of the chimney. Accordion fold it and place inside (see photos 58-60).



58



59



60

Below is a full-size drawing of the roof inner frame, which must be cut out of cardboard.

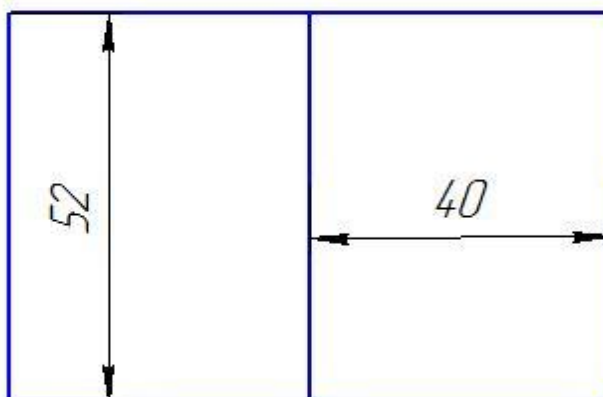

Attention! Before using a drawn, you need to make sure that its size is suitable, the same way as for the wall frame.

It is necessary to measure the width of the wall on a crocheted fabric (for me it is approximately 54 mm, see photo 22). The cardboard frame should be a couple of mm less than the crocheted fabric $54 - 2 = 52$ mm.

If you get a different value, then you should enlarge or reduce the pattern on the screen so that the size matches the measurement.

Add brightness on the screen to maximum. Attach a white paper on it and circle the drawn, then cut it and transfer to the cardboard.

Sew the chimney to the roof, placing it not in the middle, but slightly closer to one edge (see photo 61).

Next, you need to choose which of the houses you need - a pincushion or a craft box and continue according to the instructions below.

PINCUSHION HOUSE

Use a needle to make 3 holes in the roof frame at the location of the chimney (see photo 62). Cut off 3 pieces of wire approximately 10 cm (4 inches) long (see photo 63).



Pull the wire through the holes in the frame and take it out through the chimney (see photos 64-65). Glue the frame to the crocheted fabric with "Moment" superglue (see photos 66, 67). Insert the wire into the foam (see photos 68, 69).

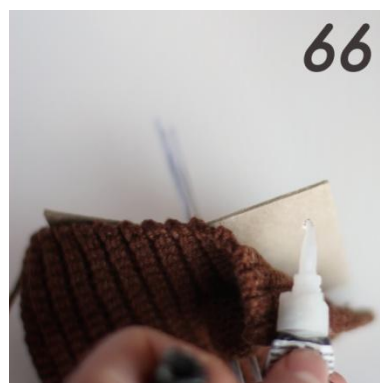

Sew the roof to the walls (see photos 70-75).

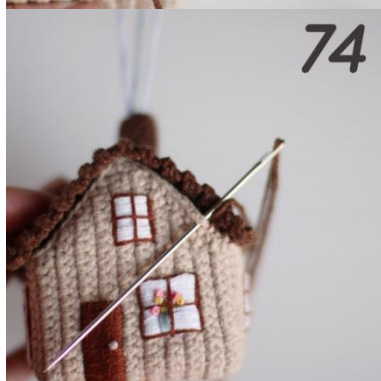
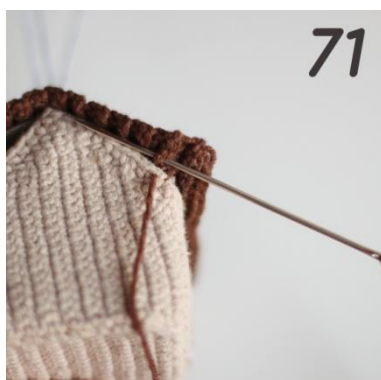
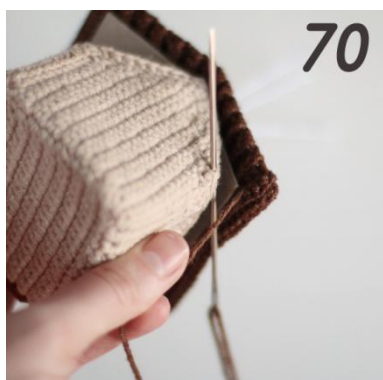

BALL PINCUSHION (Yarn B)

1: 2 loops, 6sc in 2nd loop from hook (amigurumi ring) (6l)

2: [inc]x6 (12l)

3: [sc, inc]x6 (18l)

4: [2sc, inc]x6 (24l)

5: [3sc, inc]x6 (30l)

6: [4sc, inc]x6 (36l)

7-10: 36sc (36l)

11: [4sc, dec]x6 (30l)

12: [3sc, dec]x6 (24l)

Start stuffing the ball with synthepus and continue crocheting.

13: [2sc, dec]x6 (18l)

Don't cut the thread. Completely fill the ball. Insert the needles for cutting into the ball (see photo 76).

Cut out a small circle of cardboard equal to the size of the hole in the ball. Use a needle to make 3 holes in the circle (see photo 77).

Insert the wire into the holes (see photo 78). Wrap the ends of the wire in the "rings" using round-nose pliers (see photos 79-81).



76



77



78

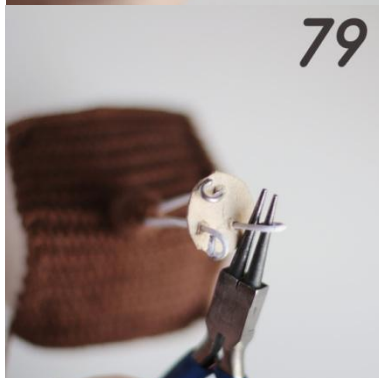

79

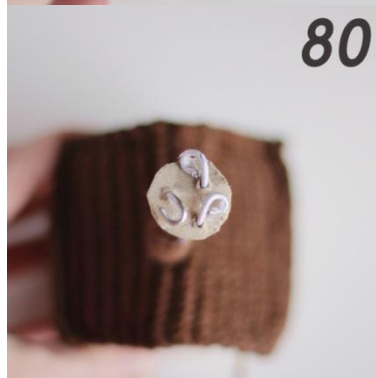

80

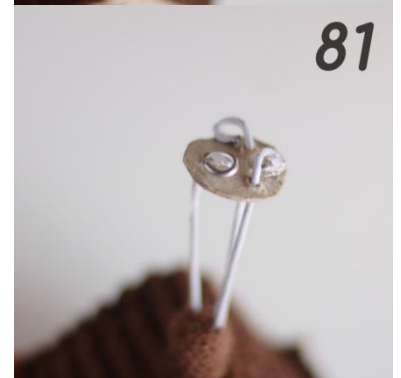

81

Insert the circle with the wire in the hole of the ball and continue crocheting (see photos 82, 83).

14: [sc, dec]x6 (12l)

15: [dec]x6 (6l) (see photo 84)

Cut and fix the thread, leaving a long end. Sew the remaining hole (see photos 84-87).





82

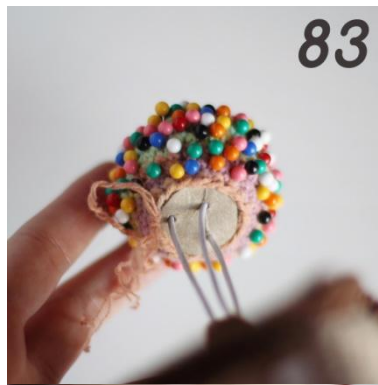

83



84

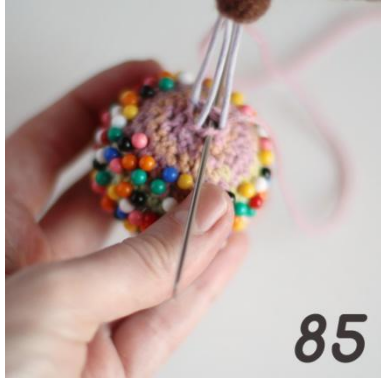

85



86



87

CRAFT BOX HOUSE

Glue neodymium magnets inside the frame and on the edge of the roof (pre-try them so that they are well magnetized when closing, see photos 88-90).



88



89



90

Sew one side of the roof to the wall (see photo 91). Pull the thread with a needle through the crossbar (see photo 92-93). Sew 2 more sides of the roof (see photos 94-99).



91

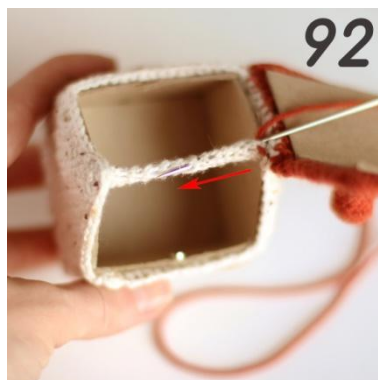

92



93

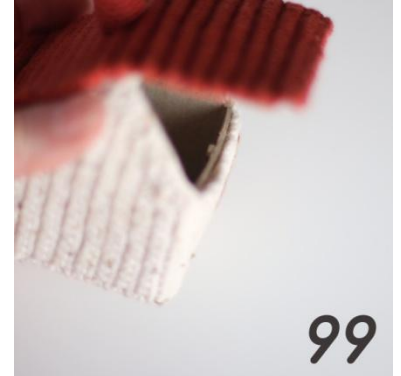

Congratulations, you did a great job and created a small miracle! Embrace your houses!



Tag my account [@loopy_pattern_design](https://www.instagram.com/loopy_pattern_design) in the Instagram under the photo with the finished work and I will show it in my Stories.

If you have any questions or difficulties with the pattern, please write to me by [E-mail](mailto:angelina@loopy-pattern-design.com) I'm sure we can find a solution together.



COPYRIGHTS



This pattern is made by the design of Angelina Taranina and is intended only for personal use. Please don't reproduce, copy, publish and distribute this crochet pattern or its parts in any way (including translating and distributing in other languages). You can sell finished products created by this pattern, but please indicate my authorship. Thank you for your respect and understanding.

